

Jug Kettle  
 Instruction Manual



## TROUBLESHOOTING GUIDE

If none of the below points apply call customer services for further assistance on 01293 652 500.

POSSIBLE CAUSE(S)	SOLUTION(S)
<b>THE KETTLE DOES NOT TURN ON</b>	
1. The kettle may not be properly connected to the power supply or the fuse may have failed.	1. Check the plug is in the socket and the switch is turned on. Replace the fuse if necessary. Note: in order to open the plug, remove the label to reveal the screw.
2. Boil dry feature may have been activated. If the kettle is accidentally switched on without water, the boil-dry device will switch off the heating element to prevent damage to the kettle.	2. Wait approximately 10 minutes for the kettle to cool down, lift and refill as normal. The kettle is now ready to use again. NOTE: If discolouration of the heating plates has occurred, this can be easily removed by descaling your kettle.
3. The element may have broken if the power neon illuminates but the kettle does not boil.	3. The element cannot be replaced. For further assistance call customer services on 01293 652 500.
4. The kettle does boil but the power neon does not illuminate.	4. The power neon may have blown, and cannot be replaced. For further assistance call customer services on 01293 652 500.
<b>THE KETTLE IS SPATTERING OUT OF THE SPOUT</b>	
1. You may have over filled the kettle.	1.1 Only fill to the max mark (1.5L). 1.2 Wait 10 seconds to allow the boiling water to settle before pouring.
2. The kettle may have descaling solutions remaining inside the body.	2. Follow the instructions in the cleaning & care section and rinse thoroughly.
3. The filter may not be in position.	3. Ensure the filter is in position. For spare filters call Dualit on 01293 652 500.
<b>MY KETTLE IS NOT SWITCHING OFF</b>	
1. Limescale may have built up inside the kettle.	1. Descale your kettle regularly (see cleaning & care).
2. Check the lid is firmly closed during use.	2. Pips on inner lid rim can be pushed out from the inside to create a tighter fit.
3. Steam is escaping from the kettle. Water may have gone down the steam tube whilst filling. You may have overfilled or tilted the kettle when filling or accidentally filled through the spout.	3. Leave the kettle for 24 hours to dry fully. Take care when filling and do not spout fill.
<b>MARKS HAVE APPEARED IN THE KETTLE</b>	
1. Small brown spots have built up inside the kettle. This is not rust, just small deposits of limescale that contain iron.	1. Descale regularly (see cleaning & care).
<b>THE KETTLE LEAKS FROM THE LID</b>	
1. The lid seal may be damaged or have a build up of limescale.	1. Clean the lid seal. If the kettle still leaks then replace the seal; for spare seals call Dualit on 01293 652 500.
<b>WATER DROPLETS COLLECT ON TOP OF THE POWER BASE</b>	
1. This is condensation and perfectly normal.	1. Dry with non abrasive cloth.



## IMPORTANT SAFETY PRECAUTIONS



### READ ALL INSTRUCTIONS

BEFORE USING THE KETTLE. KEEP THESE INSTRUCTIONS FOR FUTURE REFERENCE

- **THIS IS AN ATTENDED APPLIANCE**  
Do not leave appliance unattended during use, unplug after each use (risk of fire if an unattended appliance is left operating or plugged in).
- This appliance must not be used by children younger than 8 years old and persons with very extensive and complex disabilities. Children aged 8-14 years and persons with reduced physical, sensory or mental capabilities or lack of experience and knowledge shall not use this appliance, unless they are supervised and have been given instruction concerning the use of the appliance in a safe way and understand the hazards involved. Children shall not play with the appliance. Cleaning and user maintenance shall not be made by children unless they are older than 8 and supervised. Keep the appliance and its cord out of reach of children less than 8 years old.
- This appliance is intended for indoor household use only. If the appliance is used improperly or for professional or semi-professional purposes or if it is not used according to these instructions the Guarantee becomes invalid and Dualit refuses any liability for damage caused.

#### Electrical safety

- Before plugging in, check that the voltage on the rating label is the same as the mains supply.
- NOTE: any plug cut from the power supply cord should be disposed of immediately. Inserting any cut off plug into a 13A socket-outlet is hazardous.
- Never use the plug without the fuse cover fitted. Ensure replacement fuse is the same current value as the original. Replacement fuses are available and should be ASTA approved to BS1362.
- A short power-supply cord is to be provided to reduce risks resulting from becoming entangled in or tripping over a longer cord.
- Do not operate any appliance with a damaged lead or plug, or after the appliance malfunctions or has been damaged, cracked or dropped in any manner.
- In order to avoid a hazard, if the power cord is damaged it must, for safety reasons, be replaced by Dualit or an authorised Dualit repairer, call Dualit's Customer Helpline on +44 (0)1293 652 500
- To disconnect, turn any control to off, then remove plug from wall outlet.
- Unplug the power base from the wall socket when not in use, or before moving and cleaning.
- Ensure that the kettle is correctly positioned on the power base before switching on.

- To be protected against electrical hazards, fire and injury to persons, do not immerse the mains lead, plug, power base or kettle in water or any other liquid.
- Use the kettle only with the power base supplied and vice versa.
- Do not move the kettle while it is switched on.
- Avoid spillage on the connector.

#### General safety

- NOTE: when you lift the kettle from the base, you will see drops of moisture on the surface of the power base. This is the steam used to switch the kettle off automatically, which then condenses and escapes through vents in the underside of the kettle. This is perfectly normal, and should not be cause for alarm or return of the kettle.
- Do not operate the kettle unless the water filter is correctly in position.
- This appliance should only be operated in a dry well ventilated area.
- Do not operate without closing the lid.
- Do not fill via the spout.
- When filling hold kettle upright (maximum 15° incline).
- Do not operate the kettle unless it contains at least 250ml of water and the floor of the kettle is covered.
- Do not place the kettle, power base or mains lead on or near any hot surface, hot hob, gas burner or in a heated oven.
- Do not use the kettle for any purpose other than heating water. Otherwise, this may result in an injury caused by misuse.

- Do not fill above the bottom of the 'max' mark on the water level indicators.
- Do not operate the kettle on an inclined plane.
- Remove the kettle from its power base before filling or pouring.
- Do not remove or open the lid while the water is boiling.
- Use handles or knobs – do not touch hot surfaces.
- **If the kettle is overfilled, boiling water may be ejected.**
- **When boiling, hot steam will be emitted from the kettle. Scalding may occur if you are within 400mm of the spout.**
- Take care when pouring – pour slowly and do not over-tilt the kettle.
- Water will remain hot for a considerable time after boiling and can present a scald hazard. Keep the kettle, power base and the mains lead away from the edge of worktops and out of the reach of children.
- Allow the kettle to cool down completely before cleaning and storing.
- Do not store or use in an appliance garage or under cupboards.
- Do not use in bathroom or outdoors.
- Ensure that the lid is fully closed before switching the kettle on, otherwise it may not properly switch off.
- Do not use if dropped, cracked or damaged.
- The use of accessory attachments not recommended by Dualit may result in fire, electric shock or injury to persons.
- Do not use scouring pad or abrasive cleaner on the kettle body.
- CAUTION: to prevent damage to the appliance, do not use alkaline cleaning agents. When cleaning, use a soft cloth and a mild detergent.
- Scalding may occur if the lid is opened during the boiling cycle and the body of the kettle will get hot.
- Avoid the steam venting from the spout during and after operation. Risk of scalding.
- **Do not boil the kettle if filled with descaling solution.**
- This kettle features boil-dry protection. If the kettle is accidentally switched on without water, the boil-dry device will switch off the heating element to prevent damage to the kettle. Wait approximately 10 minutes for the kettle to cool down, lift and refill as normal. The kettle is now ready to use again. NOTE: if discolouration of the heating plates has occurred, this can be easily removed by descaling your kettle.

## SAVE THESE INSTRUCTIONS

In the interest of improving products, Dualit Ltd. reserves the right to change the product specification without prior notice.



#### INSTRUCTIONS ON ENVIRONMENT PROTECTION

Do not dispose this product in the usual household garbage at the end of its life cycle. Please hand it over to a collection point for the recycling of electrical and electronic appliances. The symbol on the product, the instruction of use or the packaging will inform you about the methods of disposal. The materials are recyclable as mentioned on its marking. By recycling, material recycling or other forms of re-utilization of old appliances you are making an important contribution to protect our environment. Please enquire at the community administration for the authorised disposal location.

## IMPORTANT: BEFORE FIRST USE

- **Don't forget to register your product at [www.dualit.com/register](http://www.dualit.com/register). It only takes 60 seconds and is for your safety.**
- Read this instruction manual before you start using the kettle. It gives you important safety information and will ensure you get the most out of your Dualit kettle.
- Keep this manual and your proof of purchase in a safe place.
- Unpack the box with care, keeping all the packaging materials until you are satisfied everything is present and in working order. Once satisfied, remove all packaging and tags from the appliance body and recycle the packaging appropriately. Do not remove tags from the cord. You may wish to keep the box to store your appliance.
- Before using the kettle for the first time, or if it has been out of use for a long time, fill to the 'max' mark and boil, then discard the boiled water and rinse the kettle out with fresh cold water.

## KNOW YOUR JUG KETTLE

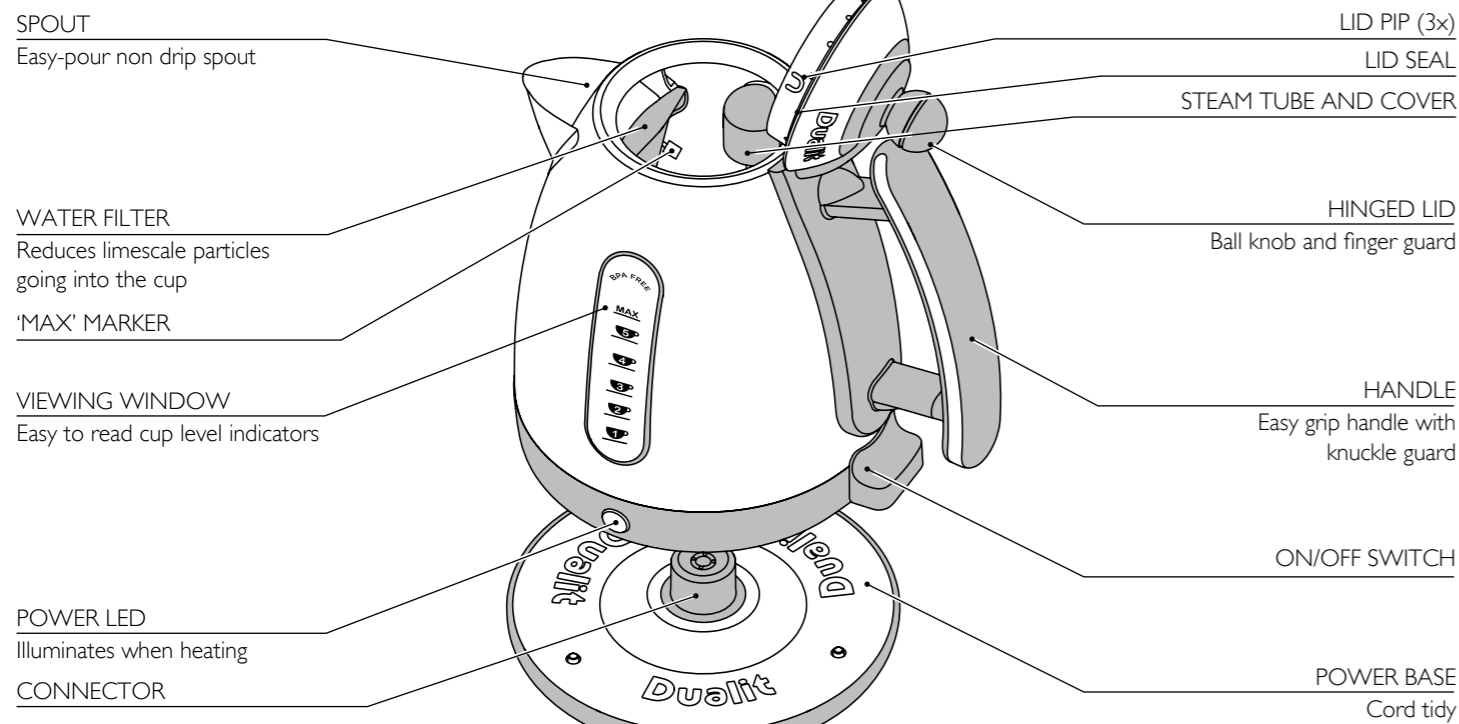

All illustrations are for representation only, your model may vary from the illustrations shown.

In the interest of improving products, Dualit Ltd. reserves the right to change the product specification without prior notice.

## SETTING UP

**WARNING: IF THE KETTLE HAS JUST BOILED, IT WILL BE FULL OF STEAM, WHICH WILL ESCAPE AS SOON AS THE LID IS OPENED. REGISTER BEFORE FIRST USE AT [WWW.DUALIT.COM/REGISTER](http://WWW.DUALIT.COM/REGISTER). IT ONLY TAKES 60 SECONDS AND IS FOR YOUR SAFETY.**

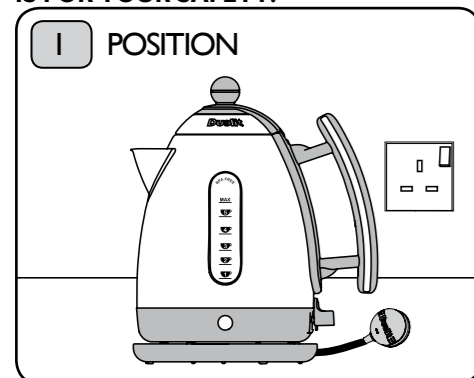

Place the kettle as close to the wall socket as possible. When in use ensure the kettle is not placed under kitchen cabinets. **DO NOT STORE OR USE YOUR KETTLE IN AN APPLIANCE GARAGE OR UNDER CUPBOARDS.**

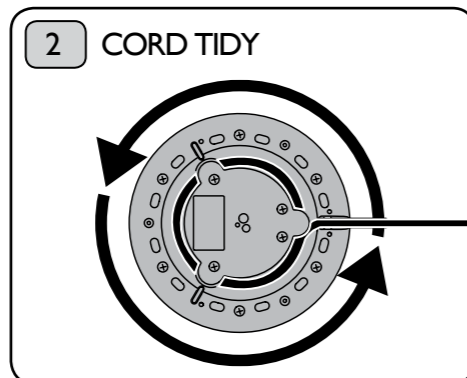

Use the shortest cord possible. Wrap excess cord round the cord tidy on the base of the kettle.

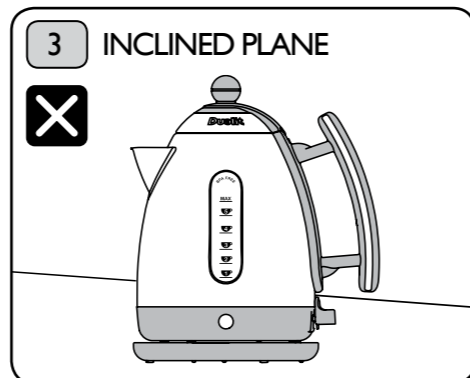

Do not operate on an inclined plane.

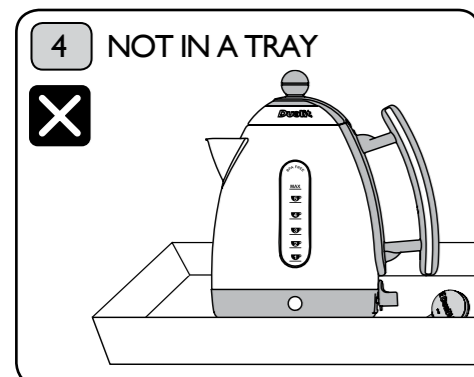

Do not operate in a tray.

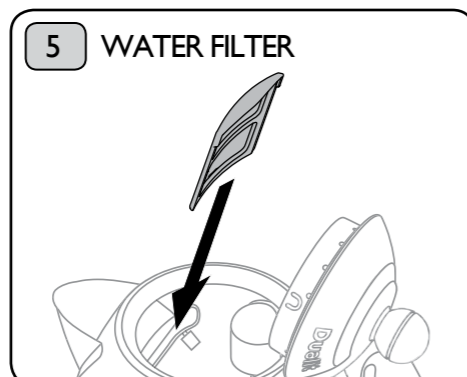

Ensure water filter is in place. **DO NOT OPERATE KETTLE UNLESS THE WATER FILTER IS CORRECTLY IN POSITION.**

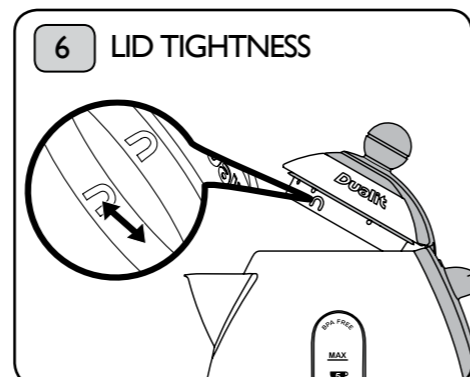

Tip: If the lid is too tight, try pushing in the pips on the inside of the lid with a spoon handle. Pushing the lid pips back out will give a tighter fit. **WARNING: IF THE LID IS TOO LOOSE, RISK OF SCALDING.**

## FILLING YOUR KETTLE

**WARNING: DO NOT LEAVE APPLIANCE UNATTENDED DURING USE, UNPLUG AFTER EACH USE (RISK OF FIRE IF AN UNATTENDED APPLIANCE IS LEFT OPERATING OR PLUGGED IN).**

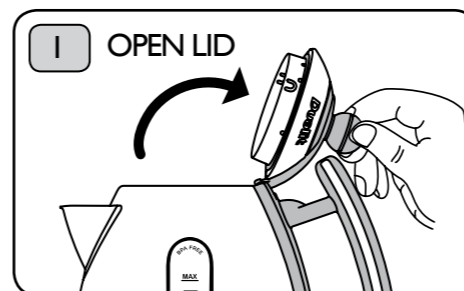

Ensure the kettle is unplugged. Remove the kettle from the power base. Pull the knob up and towards the handle to open the lid. The lid is hinged for easy opening and closing.

**WARNING: IF THE KETTLE HAS JUST BOILED, THE LID WILL BE HOT. USE THE KNOB TO OPEN THE LID.**

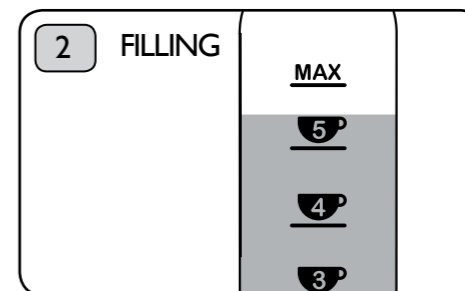

Fill the kettle through the lid opening. Use at least one cup of water (250ml). The water level must stay below the 'max' mark to save energy, only boil what you require. Keep kettle upright and level at all times when filling (maximum 15° incline). Do not tilt kettle backwards. **DO NOT OVERFILL OR FILL THROUGH THE SPOUT.**

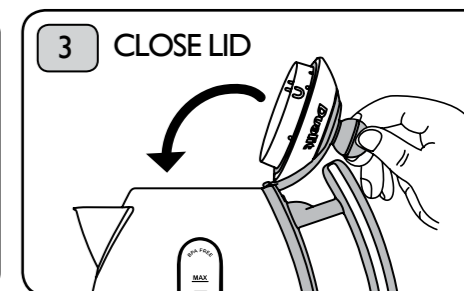

Push the lid down using the knob to close. Check that it is fully in place, otherwise the kettle may not switch off when boiling. **WARNING: IF THE KETTLE HAS JUST BOILED, THE LID WILL BE HOT. USE THE KNOB TO CLOSE THE LID.**

## BOILING WATER

**WARNING: IF THE KETTLE HAS JUST BOILED, IT WILL BE FULL OF STEAM, WHICH WILL ESCAPE AS SOON AS THE LID IS OPENED.**

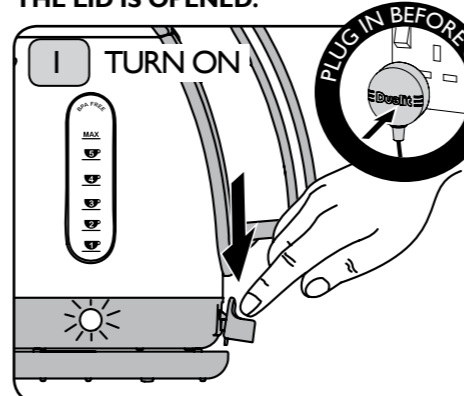

Plug the kettle into the power socket. Press the 'On/Off' switch down. The power LED will illuminate and the kettle will start to heat up. If the kettle is accidentally switched on with no water inside, the boil-dry device will switch off the heating element to prevent damage to the kettle.

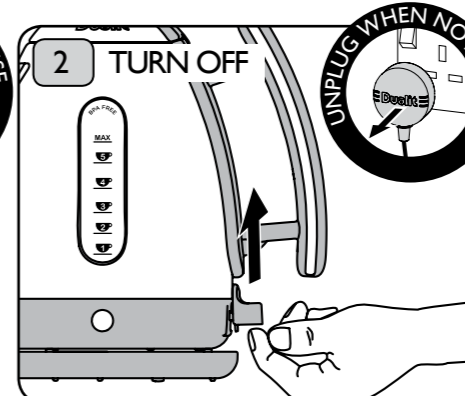

The kettle will automatically turn off after the water has boiled and the power LED will go out. To turn off before the water has boiled lift the 'On/Off' switch up. **Do not leave appliance unattended during use, unplug after each use (risk of fire if an unattended appliance is left operating or plugged in).**

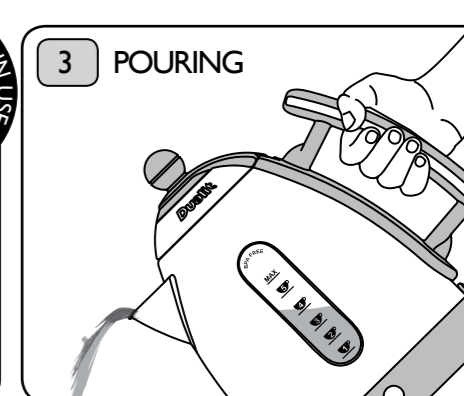

Remove kettle from the power base. When filling or carrying the kettle, do not tilt it backwards, as this may allow water to pass through the steam tube onto the control area. Should this happen, the kettle must be allowed to dry before re-using. To avoid the risk of splashing, once the kettle has boiled wait 10 seconds then pour slowly. Do not over-tilt the kettle.

## CLEANING & CARE

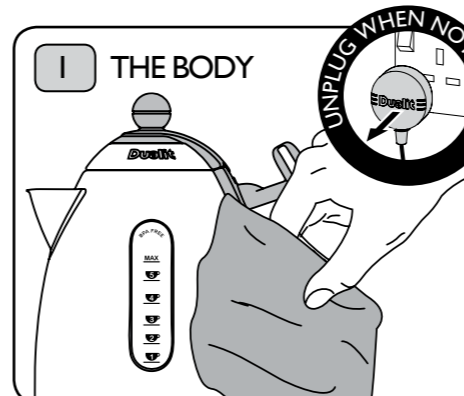

Unplug and let the kettle cool down completely before cleaning. Remove the kettle from the power base.

Wipe the outside and inside surfaces of the kettle with a damp cloth. Ensure that all connectors and sockets are kept dry. Do not immerse the kettle or power base in water or any other liquid. Do not use harsh or abrasive cleaners or solvents.

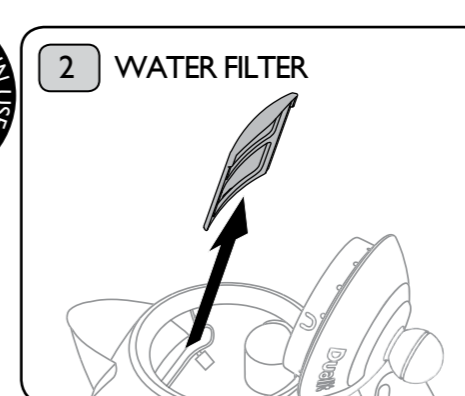

Unplug and let the kettle cool. Open the lid. Hold the top of the filter, pull up and out of the kettle. Rinse under a tap while carefully brushing it with a soft brush. Rinse the kettle out with fresh water. To replace, align the filter with the grooves in the filter holder, insert and push back into place. **DO NOT OPERATE KETTLE UNLESS THE WATER FILTER IS CORRECTLY IN POSITION.**

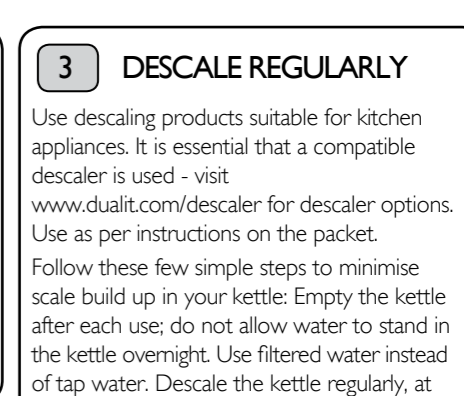

Use descaling products suitable for kitchen appliances. It is essential that a compatible descaler is used - visit [www.dualit.com/descaler](http://www.dualit.com/descaler) for descaler options. Use as per instructions on the packet. Follow these few simple steps to minimise scale build up in your kettle: Empty the kettle after each use; do not allow water to stand in the kettle overnight. Use filtered water instead of tap water. Descale the kettle regularly, at least once a month. If you live in a hard water area you may need to descale more often. When descaling has finished, empty the kettle and rinse it out a minimum of 3 times with fresh water. Then refill with fresh water; boil, then discard boiled water. **FAILURE TO DO SO CAN CAUSE INJURY. DO NOT BOIL KETTLE WITH DESCALING SOLUTION IN IT.**