

FELLOW®

MEET STAGG EKG™

A get-to-know-you guide



Soon, you and I will be inseparable. Some people say the bond between brewer and kettle is even stronger than the bond between mother and child. (And by some people, I mean I said that once. So it must be true!)

Anyway, I'm looking forward to brewing great tea and coffee together for years to come. In the meantime, check out this guide to help you get started.

A steamy story
awaits...



LET'S GET THE BREWING PARTY STARTED

With Stagg EKG you can:



Heat your water with to-the-degree temperature precision.



After your water is heated, the built-in Brew Stopwatch can time your brew for the perfect cup of tea or coffee.



Maintain your desired temperature for 60 minutes.



Pour with finesse thanks to our signature spout.



Put the calculator away. No more converting to your preferred setting.

ALL THE RIGHT PARTS

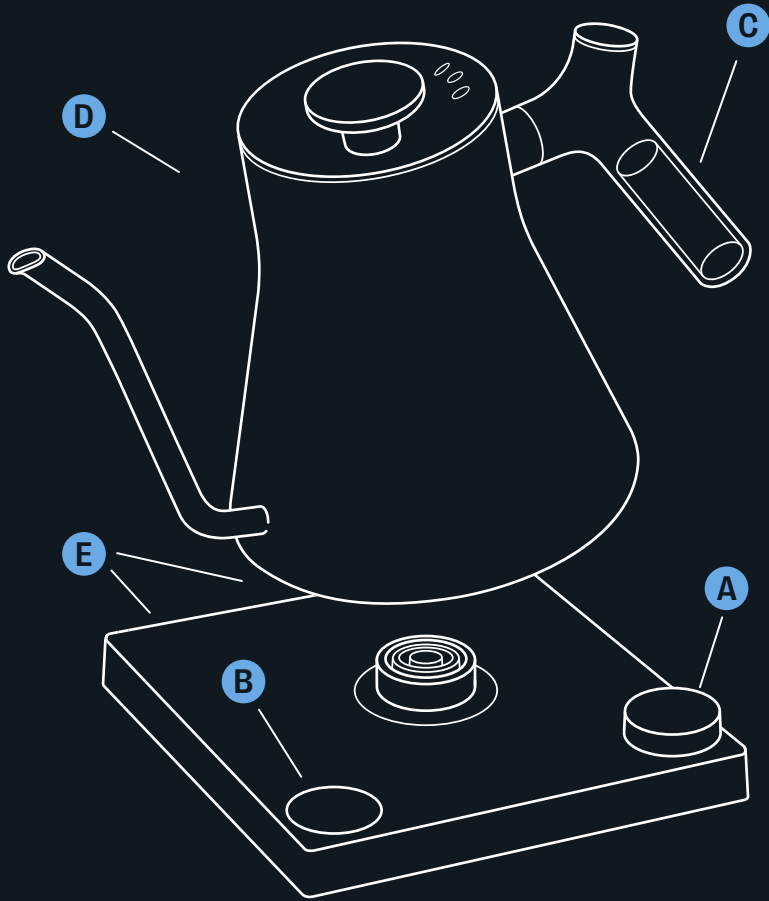

A DIAL One quick press to turn the kettle on or off. One long press to start the Brew Stopwatch. Turn to select the temperature.

B DISPLAY See how things are heating up on the LCD screen.

C HANDLE Counterbalanced for easy pouring. Ergonomic for getting a grip.

D SIGNATURE POUR SPOUT Stagg EKG's spout is shaped for a controlled, no-spill pour. No glugging or splashing here.

E HOLD MODE AND TEMP Use the rear panel toggles to choose hold mode and fahrenheit / celsius.

FEATURE GUIDE

Start here to embark on your Stagg EKG journey

①

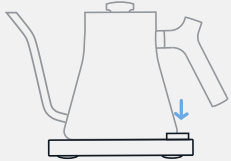

TURN ON

Push the main button to turn on your kettle.

②

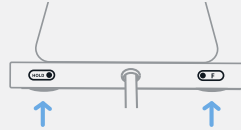

HOLD AND F/C

Use the back toggles to choose temperature and hold settings.

③



HOLD MODE

Stagg EKG's hold mode maintains your set temperature for 60 minutes when switched on. If hold mode is off, your kettle will reach set temperature, stay there for 5 minutes, then stop heating and go into standby for 15 minutes before turning off. When you have turned hold mode on, the screen will flash "HOLD ON." When your kettle is holding your set temperature, hold will appear at the top of the LCD screen.

④

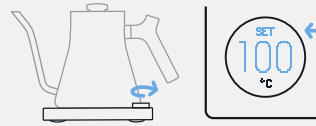

SET TEMPERATURE

Twist the main button to set desired temperature. Screen will show "SET" when temperature is being set.

⑤

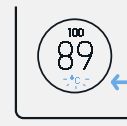

HEATING

When the F/C is blinking, the kettle is heating. The top number on your screen is your set temp. and the bottom is your current temp.

⑥

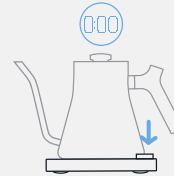

START/STOP BREW STOPWATCH

To start or stop the built-in Brew Stopwatch, hold down the main button for 2 seconds. Push main button again to stop the stopwatch and return to main screen.

⑦

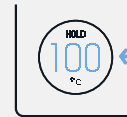

SET TEMP. REACHED

Once your SET temp. is reached, your kettle will steadily maintain that temp. thanks to the smart PID controller.

⑧



TURN OFF

Push the main button to turn off kettle.

Congrats on making it this far!

Do you like surprises as much as we do? We hope so.

There's an Easter egg in Stagg EKG's software. You have 2 hints to find it:

- The hen must leave the nest.
- One must travel across the farm and back to trigger the egg.



DO NOT PRINT THIS PAGE. INFORMATION ONLY.

		SENIOR PRINT & PACKAGING DESIGNER Nancy Spellman 560 Alabama St. nancy@fellowproducts.com San Francisco, CA 94110		05.05.23	
		FILE NAME: 789-00061_A.indd DESCRIPTION: Stagg EKG GTKYG – UK			
 CYAN	 MAGENTA	 YELLOW	 BLACK	TRIM: 4.5" x 6" SKU: ALL UK/AU/HK SKUs MODEL: EE01AA1E	SUBSTRATE: Wood free 80gsm
 PANTONE BLACK 6 C	 PANTONE 284 C	 AO MATTE VARNISH		NOTES: 8 page saddle stitch	
			REV: A	– If electronic art supplied does not match this print, contact Fellow. – This laser proof shows representative color only. Refer to the current edition of the Pantone® Formula Guide for color standards. – Fonts provided are for output of this artwork only.	